

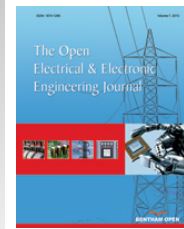

The Open Electrical & Electronic Engineering Journal

Content list available at: www.benthamopen.com/TOEEJ/

DOI: 10.2174/1874129001812010034



RESEARCH ARTICLE

Improvement of Carrier Power to Third-Order Intermodulation Distortion Power Ratio for a Power Amplifier at 5.25 GHz using LINC Method

Said Elkhaldi*, Naima Amar Touhami, Mohamed Aghoutane and Taj-eddin Elhamadi

Information system and Telecommunication Laboratory, Faculty of Science, Abdelmalek Essaadi University, Tetouan, Morocco

Received: February 21, 2018

Revised: April 4, 2018

Accepted: May 5, 2018

Abstract:

Introduction:

This paper focuses on improving the power amplifier linearity for wireless communications. The use of a single branch of a power amplifier can produce high distortion with low efficiency.

Method:

In this paper, the Linear Amplification with Nonlinear Components (LINC) technique is used to improve the linearity and efficiency of the power amplifier. The LINC technique is based on converting the envelope modulation signal into two constant envelope phase-modulated baseband signals. After amplification and combining the resulting signals, the required linear output signal is obtained. To validate the proposed approach, LINC technique is used for linearizing an amplifier based on a GaAs MESFET (described by an artificial neural network Model).

Conclusion:

Good results have been achieved, and an improvement of about 40.80 dBc and 47.50 dBc respectively is obtained for the Δ lower C/I and Δ upper C/I at 5.25 GHz.

Keywords: Carrier Power, Artificial Neural Network (ANN), Two Tones, Intermodulation Distortion IMD3, Carrier to intermodulation distortion power ratio (C/I), Linearization Techniques, LINC.

1. INTRODUCTION

In wireless communication systems, the Radio-Frequency (RF) Power Amplifiers (PAs) are one of the most critical components in designing transmitters. Recent trends in efficient and linear PA research have begun focusing more on the use of two-branched amplifier systems, than on the classical single-ended amplifier topology techniques [1]. The most popular dual-branch systems are the Doherty power amplifier [2]; the Envelope Elimination and Restoration (EER) technique and variations [3, 4]; the Linear Amplification with Nonlinear Components (LINC) technique [5]; and the modified implementation of the LINC concept (MILC) technique [6]. The outphasing power amplifier system was invented by Chireix [7] to improve the linearity and the efficiency of AM signal power amplifiers [8] invented the outphasing power amplifier system. The outphasing power amplifier is studied in [9].

The main idea behind the LINC technique consists of decomposing the envelope-varying input signal in two phase-modulated constant envelope signals. Each of which is amplified using an efficient and nonlinear amplifier. The

* Address correspondence to this author at the Information system and Telecommunication Laboratory, Faculty of Science, Abdelmalek Essaadi University, Tetouan, Morocco; E-mail: saidelkhaldi@gmail.com

combination of the amplified signals results in a linearly amplified output [10].

A popular technique of measuring the non-linearity of the amplifier is to find its carrier to intermodulation distortion power ratio (C/I), defined as the ratio of useful component output power and the Intermodulation Distortion (IMD) output power [11]. More than one carrier frequency is applied at the input of the amplifier; as a result, multiple side bands (intermodulation products) are generated due to mixing behavior introduced by the non-linearity of the device. The IMD products are usually the third-order ones that occur at $2\omega_1 - \omega_2$ and $2\omega_2 - \omega_1$. They can't be rejected by filters. The intermodulation is a major concern in microwave systems [12]. In real-world, amplifiers, due to several reasons, among which matching network components, output powers at the two fundamental frequencies and the third order intermodulation products in the upper and lower sidebands, can be different [13]. This means that the IMD at $2\omega_2 - \omega_1$ is different from the one at $2\omega_1 - \omega_2$ [14].

The design of a PA requires the designer to address several concurrent requirements on power efficiency and linearity. There exist several parameters which present a challenge during this design, such as the measurement of the Output Back-Off (OBO), the ACPR (Adjacent Channel Power Ratio), the Peak to Average Power Ratio (PAPR) and the Noise Power Ratio (NPR). In this present study, we choose the C/I ratio.

This article focuses on the LINC technique for the linearization of a power amplifier operating at 5.25 GHz. An ANN model based on real measurements describes the nonlinearity of the GaAs MESFET (MGF1923) transistor.

Results show an improvement of about 40.80 dBc and 47.50 dBc, respectively for the C/I ratio in the upper and lower sidebands. The layout of the final prototype is implemented.

2. DESIGN & IMPLEMENTATION OF THE POWER AMPLIFIER

2.1. Amplifier Design

The MGF1923 transistor operating at 5.25 GHz is used to design the power amplifier. The model of the transistor is based on an Artificial Neural Network (ANN-Model) described in detail in [15]. This approach allows for the modeling of the drain current with good accuracy, taking into account the effects of traps and self-heating, as well as other nonlinearities, such as capacities gate to source and gate to drain.

2.2. Single Tone Test

Single tone test determines some important characteristics of the power amplifier, like power gain, Power Added Efficiency (PAE), and P_{out} . Figs. (1a and 1b) illustrates the simulation results. The PAE can be defined as:

$$PAE = \frac{P_{RFout} - P_{RFin}}{P_{dc}} \quad (1)$$

Where P_{dc} is DC power.

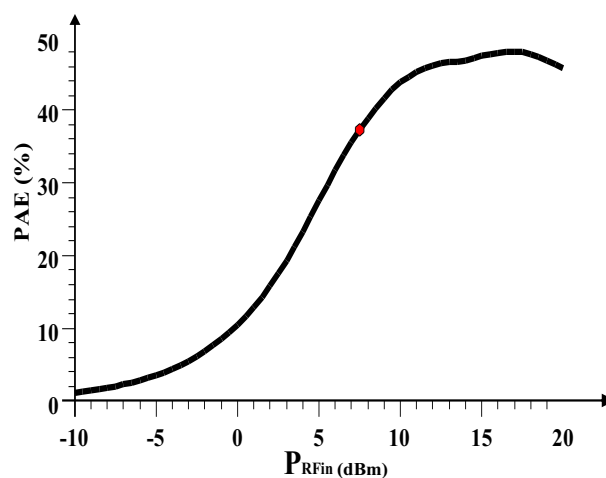

Fig. (1a). Simulated values for PAE.

From this plot, we can see that the Power Added Efficiency (PAE) = 37.5%.

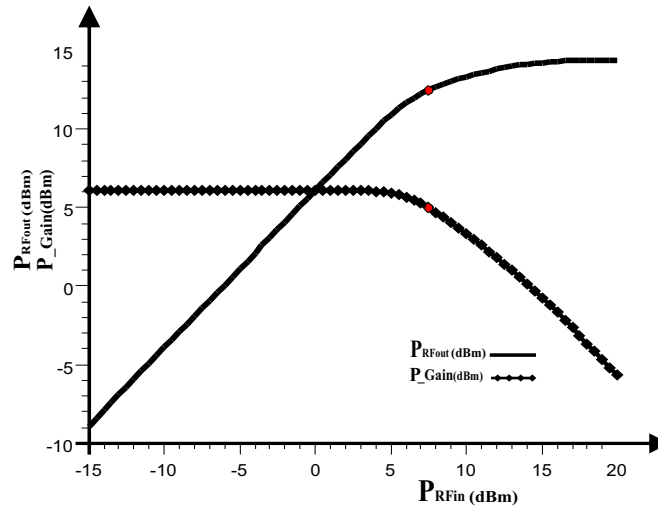

Fig. (1b). Simulated values for power gain and Pout.

From this plot, we can see that the P_{1dB} compression input power is about 7.5 dBm and the output power is about 12.5 dBm, and the gain corresponding is about 5 dBm.

2.3. Two Tones test

The IMD3 is the measure of the third-order distortion produced by a nonlinear device. This distortion product is usually so close to the carrier that it can cause interference in multichannel communication equipment. The third order Intercept Point (IP3) or (TOI) are often used as figures of merit for IMD. IP3 is an important parameter for nonlinear systems which helps to verify the linearity of the device. It can be used to define the upper limit of the dynamic range of an amplifier.

Fig. (2) illustrates the Third-Order Intercept Point. We can see that the TOI is about 22 dBm.

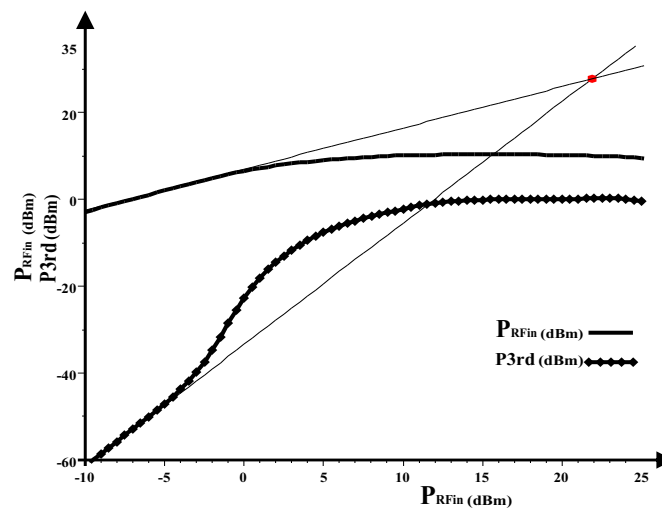

Fig. (2). Simulated Third-Order Intercept Point (TOI).

Intermodulation distortion occurs when more than one input frequency is present in the circuit under evaluation. In this work, the two input frequencies are at (5.25 ± 0.005) GHz. The carrier to intermodulation ratio (C/I), defined as the ratio between useful output power (P_{RFout}) and IMD output power (P_{IMD}), can indicate the PA nonlinear behavior. It is usually measured, using logarithmic units, in decibels below the carrier (dBc):

$$C/I = P_{RFout} / PIMD \tag{2}$$

The output spectrum of the power amplifier is shown in Fig. (3).

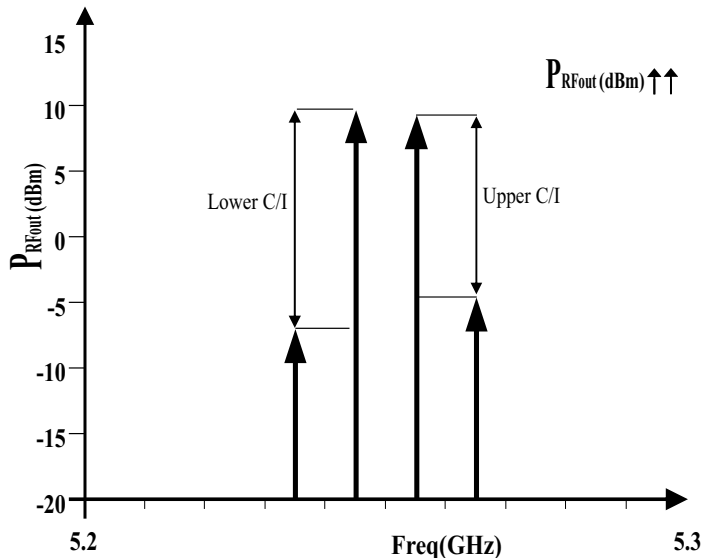

Fig. (3). Output spectrum with the two-tone test.

The simulated upper and lower C/I at these conditions are 16.7 dBc and 14 dBc, respectively.

3. LINEAR AMPLIFICATION WITH NONLINEAR COMPONENTS (LINC)

LINC is a technique whereby a linear modulation signal is converted into two constant envelope signals that are independently amplified by power amplifiers and then combined using a coupler. The conventional architecture of this technique is depicted in Fig. (4). The splitter is used at the input to split signals and realize the phase shift between the carrier and peaking amplifying paths. Then we can combine these two amplified signals with a Wilkinson combiner to obtain the signal V_{out} , which is a linear amplification of the input signal [16].

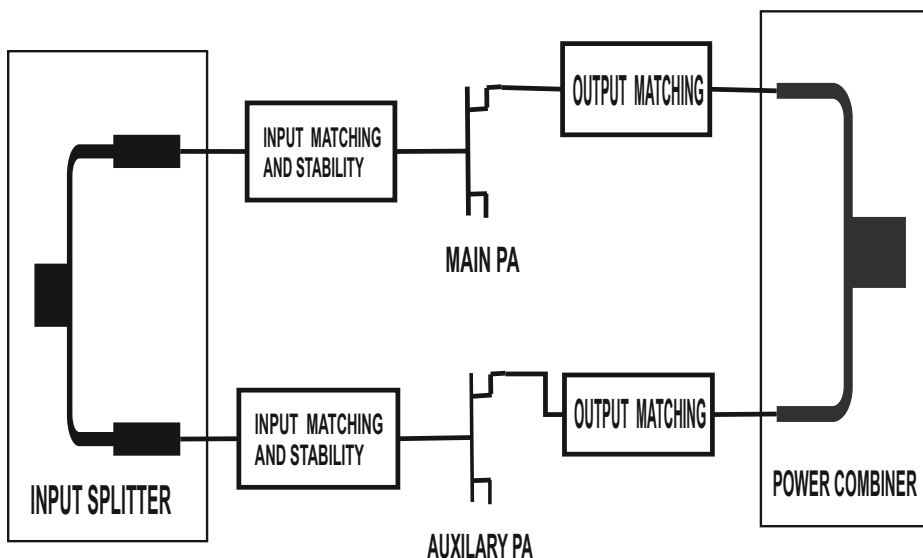

Fig. (4). Schematic of LINC system.

The input signal can be described by the following equations:

$$v_i = V(t) \cos[\omega_c t + \phi(t)] = \cos[\omega_c t + \phi(t)] \cos[\arccos V(t)] \tag{3}$$

Where ω_c is the Carrier angular frequency and ϕ is the Carrier Phase.

At the outputs of the splitter, the input signal v_i can be viewed as the sum of two signals v_1 and v_2 given by the following equations:

$$\begin{cases} v_1 = \frac{1}{2} \cos[\omega_c t + \phi(t) + \arccos V(t)] & (4a) \\ v_2 = \frac{1}{2} \cos[\omega_c t + \phi(t) - \arccos V(t)] & (4b) \end{cases}$$

The signals v_1 and v_2 will be amplified by two nonlinear power amplifiers. The output amplified signals with the same voltage gain A_v can be added to form the output voltage waveform.

The final output signal will be given by the following expression:

$$\begin{aligned} v_0 = A_v(v_1 + v_2) &= A_v \left\{ \begin{aligned} &\frac{1}{2} \cos[\omega_c t + \phi(t) + \arccos V(t)] \\ &+ \frac{1}{2} \cos[\omega_c t + \phi(t) - \arccos V(t)] \end{aligned} \right\} \\ &= A_v V(t) \cos[\omega_c t + \phi(t)] \end{aligned} \tag{5}$$

4. RESULTS AND DISCUSSION

The power amplifier is used to design the LINC system. For the input, the stabilization of the main and auxiliary device is fulfilled with a series resistor. Both the main and auxiliary amplifiers have been matched at the input and output respectively. The input signal is split into two signals and then combined using a coupler. The basic schematic of LINC system layout is reproduced in Fig. (7).

Fig. (5) illustrates the signals after linearization. The simulated upper and lower C/I at these conditions are 57.5 dBc and 61.5 dBc respectively. Fig. (6) illustrates the comparison of C/I before and after linearization.

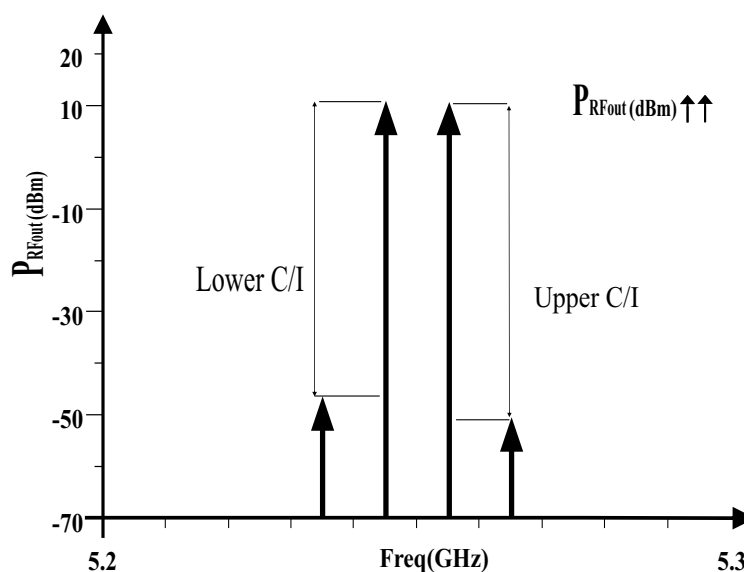

Fig. (5). Simulated IMD3 after linearization.

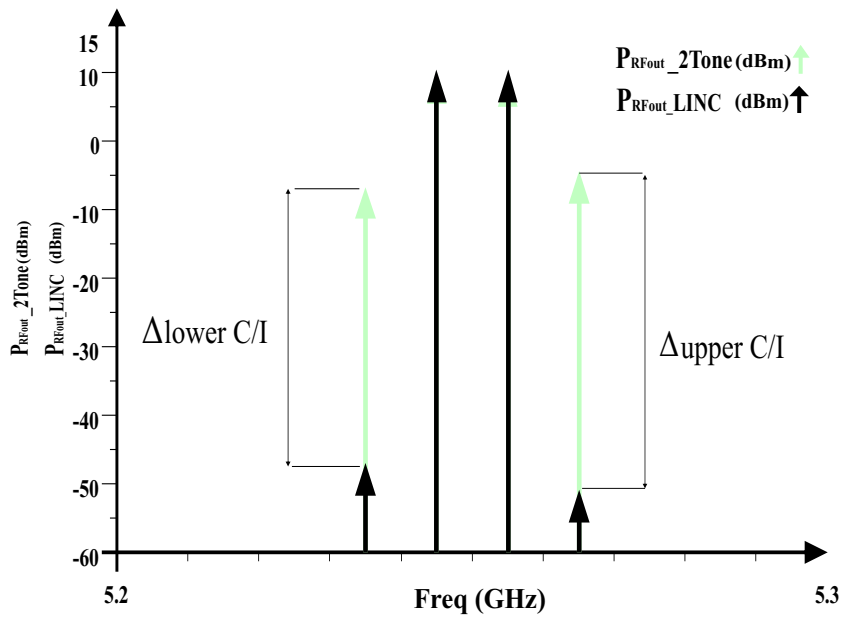

Fig. (6). Comparison before and after linearization.

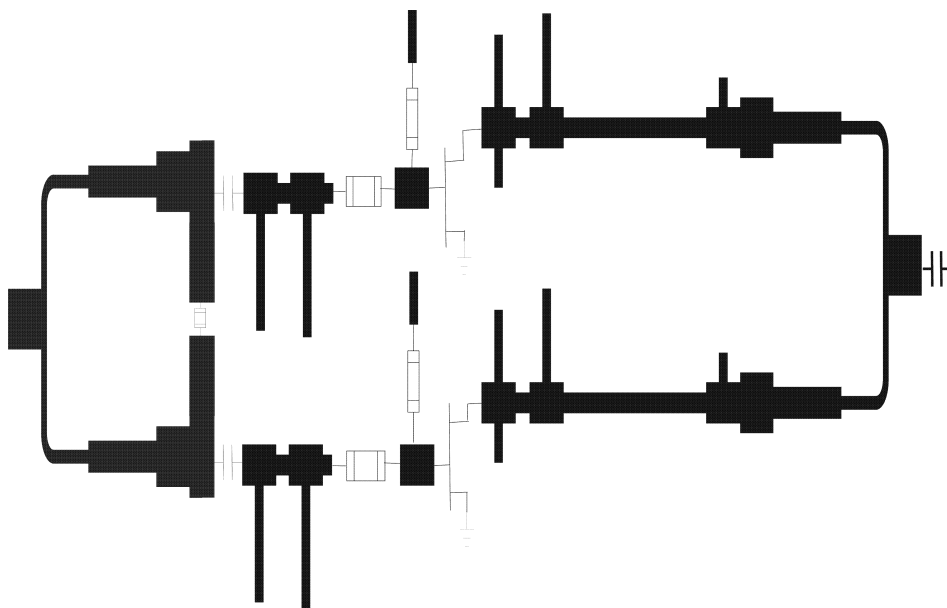

Fig. (7). Layout of LINC Power Amplifier.

Table 1 summarizes the results. We note a very good linearization. Δ lower C/I and Δ upper C/I are about 40.80 dBc and 47.50 dBc, respectively.

Table 1. C/I ratio performances.

Carrier to Intermodulation Ratio (dBc)	Upper Carrier to Intermodulation Ratio (dBc)	Lower Carrier to Intermodulation Ratio (dBc)
Before LINC	16.7	14.00
After LINC	57.50	61.50
Linearization	Δ upper C/I= 40.80	Δ lower C/I = 47.50

CONCLUSION

In this paper, the design of a RF PA operating at 5.25 GHz has been presented. The PA delivered 12.5 dBm with 37.5% PAE and upper and lower C/I are 16.7 dBc and 14 dBc, respectively. In order to improve the PA linearity, the LINC technique is used. As a result of this method, we can reduce the Carrier Power to Third-Order Intermodulation

Distortion Power Ratio. A very good linearization is obtained about 40.80 dBc for Δ lower C/I and 47.50 dBc Δ upper C/I.

CONSENT FOR PUBLICATION

Not applicable.

CONFLICT OF INTEREST

The authors declare no conflict of interest, financial or otherwise.

ACKNOWLEDGEMENTS

The authors thank referees and editors for valuable comments and helpful suggestions.

REFERENCES

- [1] A. Birafane, M. El Asmar, A.B. Kouki, M. Helaloui, and F.M. Ghannouchi, "Analyzing LINC Systems", *IEEE Microw. Mag.*, vol. 5, pp. 59-71, 2010.
[<http://dx.doi.org/10.1109/MMM.2010.935774>]
- [2] B. Kim, J. Kim, I. Kim, and J. Cha, "The Doherty power amplifier", *IEEE Microw. Mag.*, vol. 7, pp. 42-50, 2006.
[<http://dx.doi.org/10.1109/MW-M.2006.247914>]
- [3] L.R. Kahn, "Single-sideband transmission by envelope elimination and restoration", *Poc.IRE*, vol. 40, pp. 803-806, 1952.
[<http://dx.doi.org/10.1109/JRPROC.1952.273844>]
- [4] F. Wang, and D.K. Kimball, "An improved power-added efficiency 19-dBm hybrid envelope elimination and vol. restoration power amplifier for 802.11g WLAN applications", *IEEE Trans. Microw. Theory Tech.*, vol. 54, pp. 4086-4099, 2006.
[<http://dx.doi.org/10.1109/TMTT.2006.885575>]
- [5] D.C. Cox, "Linear amplification with nonlinear components", *IEEE Trans. Commun.*, vol. 12, pp. 1942-1945, 1974.
[<http://dx.doi.org/10.1109/TCOM.1974.1092141>]
- [6] W. Hamdane, A. Birafane, A.B. Kouki, and F. Gagnon, "An adaptive MILC amplification system for adaptive MQAM transmitters", In: *Chez Proc. IEEE Int. Conf., Signal Processing and Communications*, Dubai, UAE, 2007, pp. 780-783.
[<http://dx.doi.org/10.1109/ICSPC.2007.4728435>]
- [7] H. Chireix, "High-power outphasing modulation", *chez Proc. of the Institute of Radio Engineers*, vol. 23, pp. 1370-1392.
- [8] M.P. Van der Heijden, M. Acar, J.S. Vromans, and D.A. Calvillo-Cortes, "A 19W High-Efficiency Wide-Band CMOS-GaN Class-E Chireix RF Outphasing Power Amplifier", In: *Digest of the IEEE MTT-S International Symposium on Microwave*, 2011, pp. 1-4.
- [9] S. Hamedi-Hagh, and C.A.T. Salama, "Wideband CMOS integrated RF combiner for LINC transmitters", In: *Digest of the IEEE MTT-S Symposium on Radio Frequency Integrated Circuits (RFIC)*, 2003, pp. 41-43.
- [10] M. Helaloui, S. Boumaizal, A. Ghaze, and F.M. Ghannouchi, "Digital Compensation of Branches Imbalance Effects in LINC Transmitters", In: *Proc. The 16th International Conf., Microelectronics*, 2004, pp. 688-691.
[<http://dx.doi.org/10.1109/ICM.2004.1434759>]
- [11] I.J. Bahl, *Fundamentals of RF and Microwave Transistor Amplifiers.*, John Wiley & Sons, 2009.
[<http://dx.doi.org/10.1002/9780470462348>]
- [12] S.A. Maas, *Nonlinear Microwave and RF Circuits.*, 2nd ed Artech House, 2003.
- [13] P. Colantonio, F. Giannini, and E. Limiti, *High efficiency RF and microwave solid state power amplifiers.*, Wiley, 2009.
[<http://dx.doi.org/10.1002/9780470746547>]
- [14] N.B. Carvalho, and J.C. Pedro, "Two-tone IMD asymmetry in microwave power amplifier", *Digest of the IEEE MTT-S International Microwave Symposium.*, vol. 1, pp. 445 - 448, 2000.
[<http://dx.doi.org/10.1109/MWSYM.2000.861062>]
- [15] T.E. Elhamadi, M. Boussouis, N.A. Touhami, and M. Lamsalli, "Neuro-space mapping modeling approach for trapping and self-heating effects on GaAs and GaN devices", *Int. J. RF Microw. Comput.-Aided Eng.*, 2017.
[<http://dx.doi.org/10.1002/mmce.21106>]
- [16] D.M. Pozar, *Microwave engineering.*, Wiley, 2005.