

Performance Comparison of Three Different Controllers of Proton Exchange Membrane Fuel Cell

Liping Fan^{*,1}, Chong Li^{1,2} and Kosta Boshnakov²

¹College of Environment and Safety Engineering, Shenyang University of Chemical Technology, Shenyang, Liaoning, 110142, P.R. China

²University of Chemical Technology and Metallurgy, 1756 Sofia, Bulgaria

Abstract: Proton exchange membrane fuel cells (PEMFCs) are promising clear and efficient new energy sources. An excellent control system is a normal working prerequisite for maintaining a fuel cell system in correct operating conditions. Conventional controllers could not satisfy the high performance to obtain the acceptable responses because of uncertainty, time-change, nonlinear, long-hysteresis and strong-coupling characteristics of PEMFCs. Based on the dynamic model of PEMFC, an adaptive fuzzy sliding mode controller is proposed for PEMFC to realize constant voltage output and reliability service. Three different controllers, including fuzzy controller, fuzzy sliding mode controller and adaptive fuzzy sliding mode controller, are designed and compared. Simulation results show that the proposed adaptive fuzzy sliding mode controller for PEMFC can get satisfactory controlling effects.

Keywords: Adaptive control, fuel cells, fuzzy logic, sliding mode control.

1. INTRODUCTION

Energy resource is indispensable for the survival and development for human life. The need for energy resource increases with the process of global industrialization [1, 2]. In the breakneck quest for global industrialization, traditional fossil fuels, such as petroleum, natural gas and coal, have been largely used and are gradually dying up. This brings shortage of energy supply and a rise in price which have directly resulted in worldwide energy crisis. The growing crisis in energy calls for effective countermeasures. Meanwhile, a lot of unnecessary environmental losses have been caused by gaseous and solid pollution emissions during conventional power generation process [3, 4]. Therefore, people in the whole world are, in an attempt to explore and exploit some advanced renewable energy sources, to meet high energy efficiency and null pollution targets [5-7].

A fuel cell is comparable to an electrolytic cell or a battery, where chemicals are oxidized or reduced to produce electricity and, simultaneously, only water vapor as a main by-product. Combined with high energy efficiency, the fuel cell, as a kind of renewable energy, is recognized as the most promising source of energy [8]. In the process of alternative energy development, fuel cell technology is playing the vital role, so the researchers interest has been increasing in recent years.

There are many types of fuel cells, among them, the most important is the type of proton exchange membrane fuel

cell (PEMFC). Compared with other fuel cells, PEMFC is featured with quick start-up, high current density when continue operating, low working temperature and efficient generation of high power densities. Based on these features, PEMFC is considered the most potential one among the new alternative energy sources [9, 10].

In order to meet the requirements of performance improvement and increasing safety and reliability, it is necessary to design a satisfying control on proton exchange membrane fuel cell. Due to the PEMFC's characteristics of time-change, indeterminacy, strong-coupling and non-linearity, the traditional control methods could not receive positive responses [11]. It is a challenging task to establish satisfying control systems for fuel cells to get a stable and efficient power response. Considering the nonlinearity and uncertainty, the controller, which is intelligent or self-adaptable, is in need of further development [12].

Sliding mode control (SMC) method is one of the effective nonlinear control approaches to uncertain time delay systems, since it could provide the system states with an invariance property to uncertainties and perturbation once the system states are moved and stabled in the sliding mode. Sliding mode control features such valuable properties as low sensitivity to external disturbances and robustness with respect to plant parameter uncertainties and variations. However, because of the time delay problem in practical applications, the discrete switch control peculiarity of sliding mode control may cause the same class of problems called chattering. Chattering has potential to engender the unpredictable distinction to affect the control performance and deviate from the expectant control target of the system [13, 14]. Many efforts were aimed at elimination of chattering.

*Address correspondence to this author at the College of Environment and Safety Engineering, Shenyang University of Chemical Technology, Shenyang, Liaoning, 110142, P. R. China; Tel: 86-24-89385088; Fax: 86-24-89385088; E-mail: flpsd@163.com

Fuzzy logic control is an active research area as a useful tool for control system schemes. As a significant embranchment of intelligent control, FLC has a considerable background that is applicable to many industries, including chemical engineering, metallurgy, sewage treatment, power plants among other industries. However, fuzzy control is not suitable to the high requirements of systematic stability and control precision, the leading cause can be chalked up to lacks of the standard formats for fuzzy rules and synthesis technique [15-18].

Adaptive fuzzy sliding mode control scheme utilizes fuzzy control to overcome the effect of model inaccuracy and weaken the chattering caused by the common SMC. Meanwhile, it utilizes adaptive control to adjust the fuzzy coefficient automatically to resist load disturbance. So it improves rapidity and stationary of system dynamic response [19].

In this study, an adaptive fuzzy sliding mode control system that can perform constant voltage output of PEMFC has been realized. This paper is structured as follows. Section 2 describes the mathematical model of a typical proton exchange membrane fuel cell. A brief description of design of an adaptive fuzzy sliding mode controller is given in Section 3. Section 4 presents the simulation results. Finally, our work of this paper is summarized in the last section.

2. MODEL ESTABLISHMENT

In order to study the overall operation performance of PEMFC system, the adequate system modeling of a proton exchange membrane fuel cell is a powerful tool as the first step to design optimal and intelligent control strategies of PEMFC system in terms of operating conditions without extensive calculations [20].

Electrochemical process of PEMFC starts from the anode chamber in an oxygen-poor environment. In the anode chamber, hydrogen is brought by flow plate channels, then is divided into hydrogen protons H^+ and electrons e^- by anode catalyst. The other chamber which is an oxygen-rich environment, called the cathode chamber, is separated from the anode chamber by a proton exchange membrane that is permeable to protons, but impermeable to oxygen. Proton H^+ permeates through the proton exchange membrane from anode chamber to cathode chamber while electron e^- travels to cathode chamber over external electrical circuit. In the cathode chamber, electron e^- and proton H^+ combine with oxygen molecule O_2 attached on the cathode surface to produce heat and water H_2O in the presence of catalyst. The above described reactions can be represented by the following equations [21, 22]

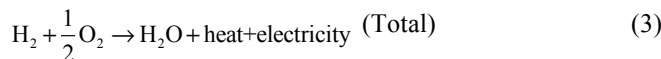
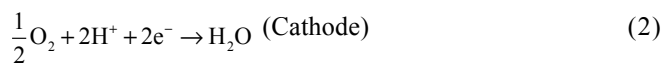

The output voltage V_{fc} which is generated by a single cell, could be demonstrated as the following equations:

$$V_{fc} = E_{\text{nernst}} - V_{\text{act}} - V_{\text{ohmic}} - V_{\text{con}} \quad (4)$$

in which E_{nernst} represents reversible voltage, which is the thermodynamic potential of the cell, and

$$E_{\text{nernst}} = 1.229 - 0.85 \times 10^{-3}(T_{fc} - 298.15) + 4.31 \times 10^{-5} T_{fc} \left[\ln(P_{H_2}) + \frac{1}{2} \ln(P_{O_2}) \right] \quad (5)$$

where P_{H_2} and P_{O_2} (atm) are respectively hydrogen and oxygen pressures, T_{fc} (K) is operating temperature, and V_{act} is the voltage drop, caused by the activation of anode and the cathode [23, 24]

$$V_{\text{act}} = 0.9514 - 3.12 \times 10^{-3} T_{fc} - 7.4 \times 10^{-5} T_{fc} \ln(C_{O_2}) + 1.87 \times 10^{-4} T_{fc} \ln(i) \quad (6)$$

where i (A) is current, C_{O_2} is the oxygen concentration. V_{ohmic} is ohmic voltage drop, related to the conduction when protons get through the solid electrolyte. In the meanwhile, electrons go through internal resistance, and the expression can be shown as:

$$V_{\text{ohmic}} = i(R_M + R_C) \quad (7)$$

where R_C (Ω) is contact resistance of electron flow, and R_M (Ω) is the resistance when proton goes through the membrane, the expressions can be described as follows:

$$R_M = \frac{\rho_M \cdot l}{A}, \quad (8)$$

$$\rho_M = \frac{181.6 \left[1 + 0.03 \left(\frac{i}{A} \right) + 0.062 \left(\frac{T_{fc}}{303} \right)^2 \left(\frac{i}{A} \right)^{2.5} \right]}{\left[\psi - 0.634 - 3 \left(\frac{i}{A} \right) \right] \exp \left[4.18 \left(\frac{T_{fc} - 303}{T_{fc}} \right) \right]}$$

where ρ_M ($\Omega \cdot \text{cm}$) is the specific resistivity of membrane, l (cm) is the thickness of membrane, A (cm^2) is the active area of membrane, and ψ is a specific coefficient for every type of membrane; V_{con} represents the voltage drop caused by the effects of mass transportation, which affects the reacting gases concentration and can be demonstrated as the following expression:

$$V_{\text{con}} = -B \ln \left(1 - \frac{i}{i_{\text{max}}} \right) \quad (9)$$

where B (V) is a constant which depends on the type of fuel cell, i_{max} is the maximum current of the fuel cell. The output power of the single proton exchange membrane fuel cell is:

$$P_{fc} = V_{fc} i \quad (10)$$

where i is the output current of the fuel cell. A generally accepted dynamic model of PEMFC is shown in Fig. (1). where q_{O_2} is the input oxygen molar flow, q_{H_2} is the input hydrogen molar flow, K_{H_2} is the molar constant of hydrogen valve, and K_{O_2} is the molar constant of oxygen valve, V_{fc}^* is the given output voltage.

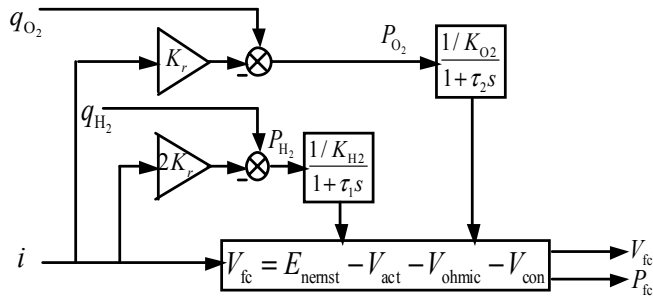

Fig. (1). PEMFC dynamic model.

Basing on the above described mathematical model, a simulation model of PEMFC can be set up by using Matlab/Simulink software [25]. Parameters used in the simulations are those of the Ballard Mark V fuel cell [26].

3. DESIGNING AN ADAPTIVE FUZZY SLIDING MODE CONTROLLER

3.1. Structure of the Adaptive Fuzzy Sliding Mode Control

In the aspect of control methods, fuzzy control and sliding mode control are different from conventional control theory, and each of them has its advantages and disadvantages. Fuzzy control needs not have an accurate mathematical model of controlled plant and has good robustness. However, once control rule and coefficient are fixed, fuzzy control cannot adapt to condition change well. Sliding mode control has the advantage of fast response characteristic, and it is not sensitive to parameter variation and fast load changes. But sliding mode control is easy to bring about chattering. Combining fuzzy control with sliding mode control can lighten or eliminate chattering caused by sliding mode control, but it still reckons on experiences, and that the controller does not have the ability of parametric adapting. Hence, an adaptive fuzzy sliding mode controller is designed to solve this issue.

A closed-loop adaptive fuzzy sliding mode control system is designed as shown in Fig. (2).

3.2. Selection of Sliding Mode Surface

The control of PEMFC in this paper is aimed to keep the output voltage V_{fc} equal to the given output voltage V_{fc}^* . So the error $e(k)$ can be defined as:

$$e(k) = V_{fc}^* - V_{fc} \quad (11)$$

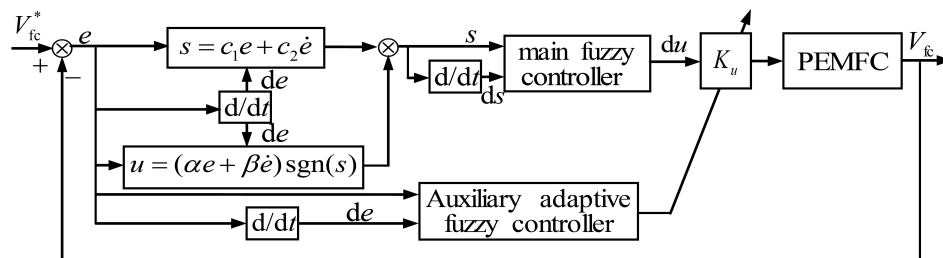

Fig. (2). Closed-loop adaptive fuzzy sliding mode control system.

A sliding mode surface is defined as the following equation:

$$s(k) = c_1 e(k) + c_2 \dot{e}(k) \quad (12)$$

When the control input is adjusted to make the movement point stabilized on the sliding mode surface, the system tends to be stable; here $s = \dot{s} = 0$, namely,

$$ds(k) = s(k) - s(k-1) = 0 \quad (13)$$

If there is no fast load change, SMC could make the movement point stabilized on the sliding mode surface. If there is a fast load change, the movement point would deviate from the sliding mode surface. In order to let the movement point return back to the sliding mode surface fast and accurately, the following solutions are considered in the designing process:

- 1) The controller is designed by a proportion switching control method so that it can meet the requirement to the existence of a sliding mode. The control law is chosen as:

$$u = (\alpha e + \beta \dot{e}) \text{sgn}(s) \quad (14)$$

- 2) The control input is adjusted by using a main fuzzy controller according to error and the change of the error, that is, the fuzzy control output u^* approaches to the system control input u under no fast load changes.
- 3) An auxiliary adaptive fuzzy controller is applied to adjust the proportionality factor K_u of the main fuzzy controller to follow the load changes, and weaken the chattering caused by sliding mode control.

3.3. Construction of the Main Fuzzy Controller

To make the movement point stabilized on the sliding mode surface, the distance $s(k)$ to the sliding mode surface and the speed $sc(k)$ approaching to the sliding mode surfaces $s(k)$ and $sc(k)$, are used as the dual inputs of the main fuzzy controller. $s(k)$, $sc(k)$ and the control output $u(k)$ of the main fuzzy controller are given as follows:

$$s(k) = c_1 e(k) + c_2 \dot{e}(k) \quad (15)$$

$$sc(k) = s(k) - s(k-1) \Delta u(k) \quad (16)$$

$$u(k) = u(k-1) + \Delta u(k) \quad (17)$$

Here $\Delta u(k)$ is the inferred change of duty ratio by the main fuzzy controller.

In the main fuzzy controller, the triangular type membership functions are chosen for $s(k)$, $sc(k)$ and $u(k)$. The fuzzy

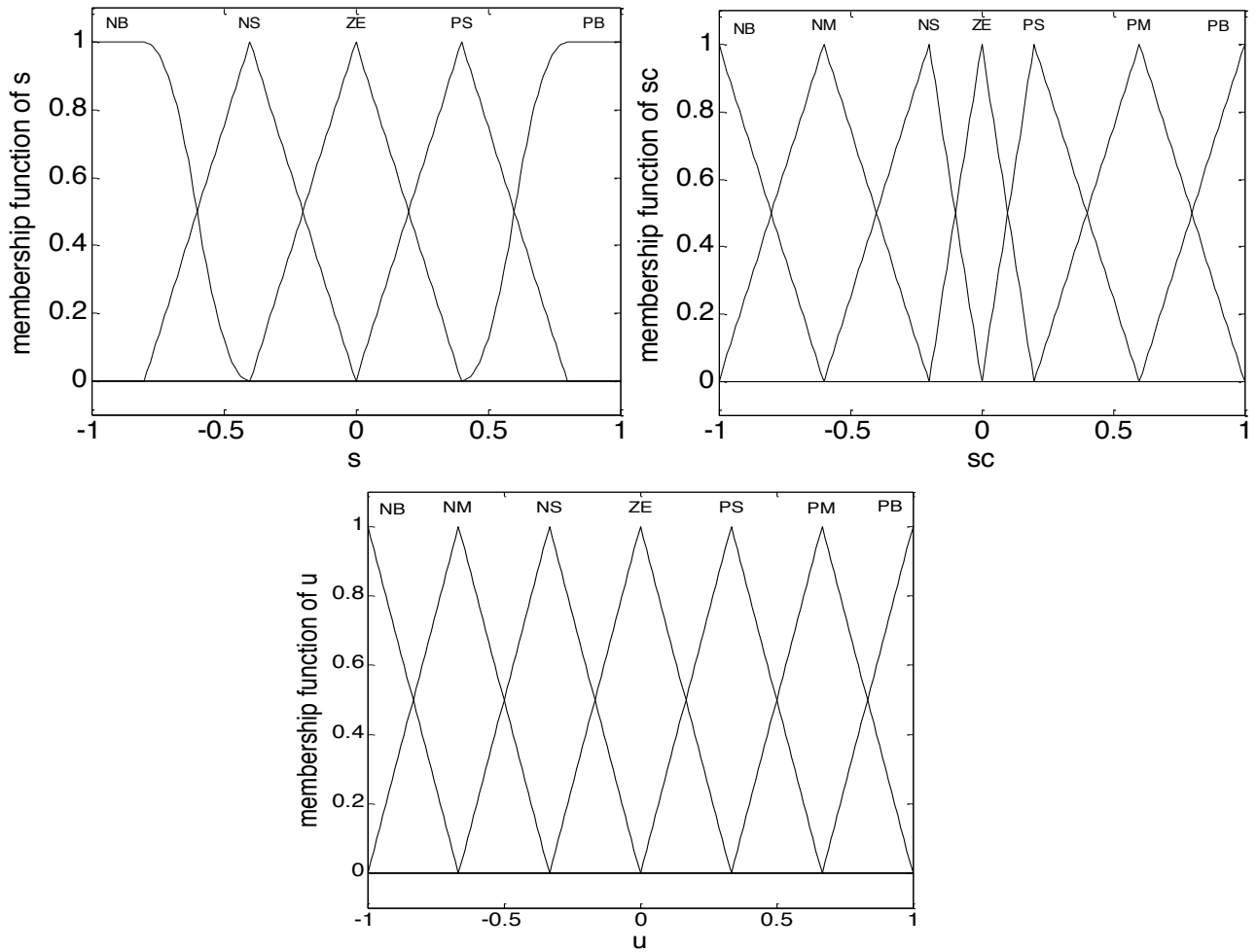

Fig. (3). Membership functions of s , sc and u for the main fuzzy logic controller.

domain for $s(k)$, $sc(k)$ and $u(k)$ is $[-1,1]$. Wherein the fuzzy set for $s(k)$ is $\{NB, NS, ZE, PS, PB\}$, and for $sc(k)$ and $u(k)$ is $\{NB, NM, NS, ZE, PS, PM, PB\}$. In this paper, the output control u of the main fuzzy controller is designed as q_{O_2} . The fuzzy control rule base of the main fuzzy controller is shown in Table 1. To calculate the output of the fuzzy controller, the type of defuzzification is the centroid method, and the Mamdani's method is used for fuzzy inference engine.

The membership functions of the main controller for the inputs and outputs are shown in Fig. (3). Fig. (4) shows the 3-dimensional representation of control variable u for fuzzy variable (s, sc).

3.4. Construction of the Auxiliary Adaptive Fuzzy Controller

An auxiliary adaptive fuzzy controller with dual input is designed to adjust the proportionality factor K_u of the main fuzzy controller to obtain rapider response speed and better steady-state behavior. The error e , the change of error ec and the control output K_u of the auxiliary adaptive fuzzy controller are given as:

$$e(k) = V_{fc}^* - V_{fc} \tag{18}$$

$$ec(k) = e(k) - e(k-1) \tag{19}$$

$$K_u(k) = K_u(k-1) + \Delta K_u(k) \tag{20}$$

and $\Delta K_u(k)$ is the inferred change of duty ratio by the auxiliary adaptive fuzzy controller.

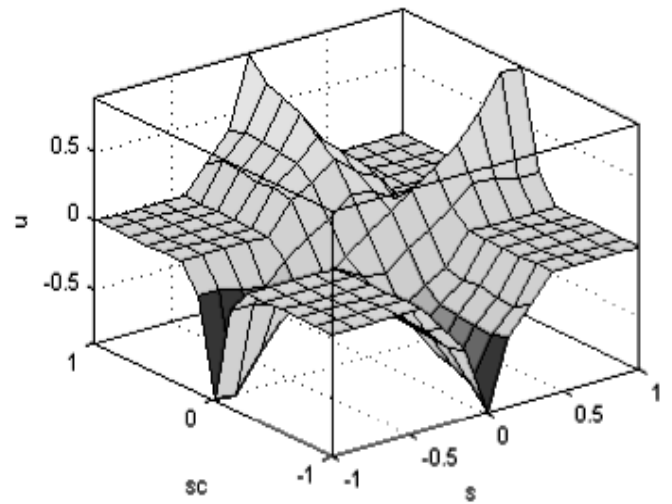

Fig. (4). 3-dimensional representation of control variable u of the main fuzzy controller.

The triangular type membership function is chosen for e , ec and K_u . The fuzzy domain for e, ec is $[-1, 1]$, and for K_u is

Table 1. Control rules of the main fuzzy controller.

u		s						
		NB	NM	NS	ZE	PS	PM	PB
sc	NB	ZE	ZE	ZE	NB	ZE	ZE	ZE
	NS	ZE	ZE	ZE	NS	ZE	ZE	ZE
	ZE	NB	NM	NS	ZE	PS	PM	PB
	PS	ZE	ZE	ZE	PS	ZE	ZE	ZE
	PB	ZE	ZE	ZE	PB	ZE	ZE	ZE

Table 2. Control rules of the adaptive fuzzy controller.

K_u		E						
		NB	NM	NS	ZE	PS	PM	PB
ec	NB	NB	NB	NB	NB	NM	NS	ZE
	NM	NB	NB	NB	NM	NS	ZE	PS
	NS	NB	NB	NM	NS	ZE	PS	PM
	ZE	NB	NM	NS	ZE	PS	PM	PB
	PS	NM	NS	ZE	PS	PM	PB	PB
	PM	NS	ZE	PS	PM	PB	PB	PB
	PB	ZE	PS	PM	PB	PB	PB	PB

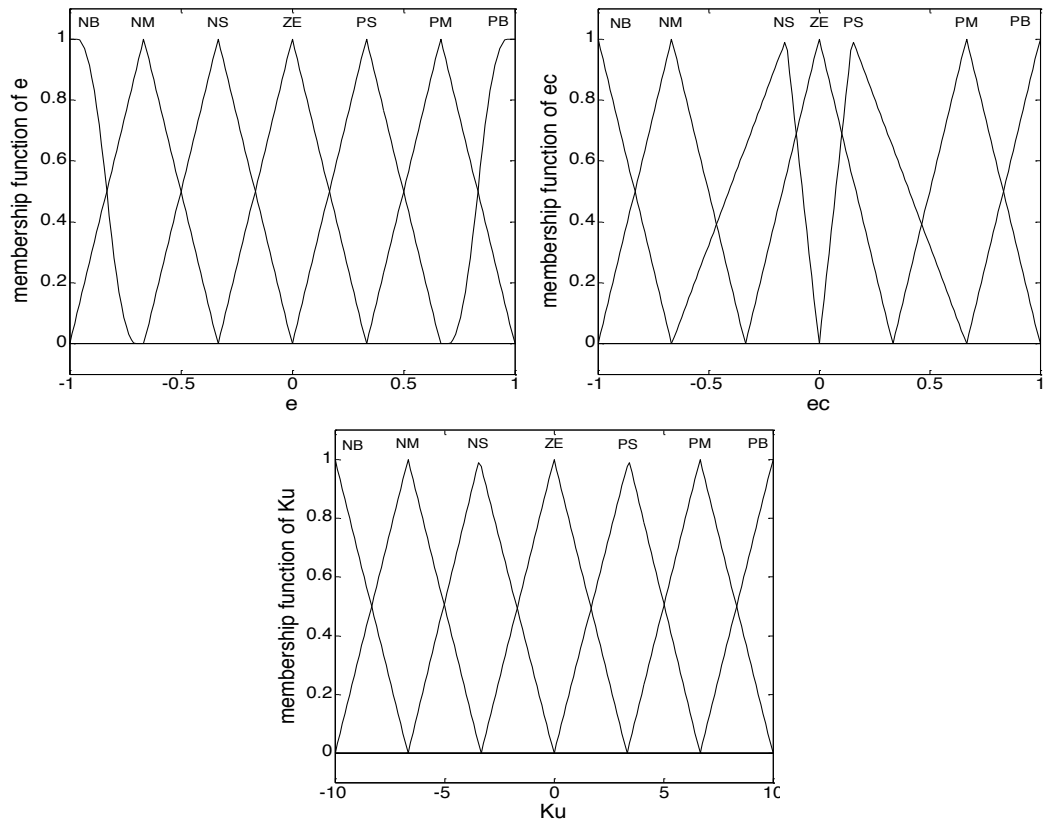

Fig. (5). Membership functions of e , ec and K_u of the auxiliary adaptive fuzzy controller.

$[-10, 10]$. The fuzzy set for e , ec and K_u is $\{NB, NM, NS, ZE, PS, PM, PB\}$. The output control K_u of the auxiliary

adaptive fuzzy controller is the value of proportionality factor in the main fuzzy controller.

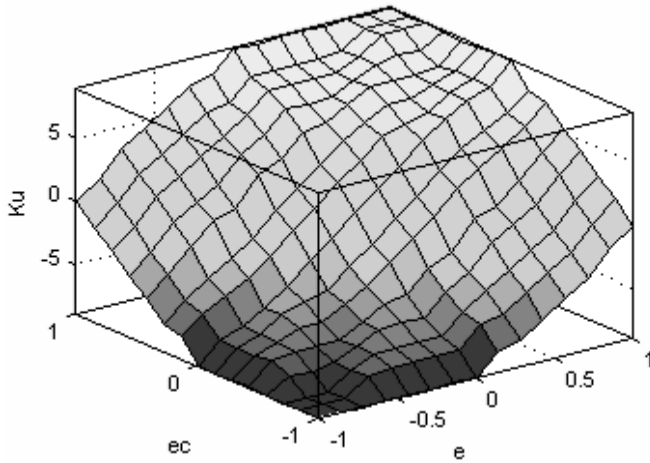

Fig. (6). 3-dimensional representation of u for e, ec of the auxiliary adaptive fuzzy controller.

The fuzzy control rule base of the auxiliary adaptive fuzzy controller is shown in Table 2. The membership functions for the auxiliary controller are shown in Fig. (5), and Fig. (6) shows the 3-dimensional representation of control variable K_u for fuzzy variables (e, ec).

4. RESULTS AND DISCUSSION

To verify the control effect caused by the designed control scheme, simulation operation was carried out in the MATLAB/Simulink platform. The reference setting output voltage of fuel cell is 1.5V and the load changes from 5Ω to 10Ω at 5s. The main parameters of the proton exchange membrane fuel cell used in the simulation are shown in Table 3.

Fig. (7) shows the changing curves of the output voltage and power when there is no controller existing in the PEMFC system. It can be seen from Fig. (7) that the output voltage of the proton exchange membrane fuel cell system without controller undergoes an obvious jumping and then deviates from its original steady value noticeably when the load changes from 5Ω to 10Ω .

The controllers are designed to make the PEMFC keep a constant output voltage by adjusting the oxygen flow. Three control schemes are designed and compared: fuzzy control, conventional fuzzy sliding mode control and adaptive fuzzy sliding mode control.

For the fuzzy control scheme, the quantifying factors are $K_e=1, K_{ec}=0.03$ and $K_u=300$. For the conventional fuzzy sliding mode control scheme, the sliding mode surface is $s(k) = c_1 e(k) + c_2 \dot{e}(k)$. The fuzzy controller is a constant coefficient fuzzy controller, whose quantifying factors are $K_s=1, K_{sc}=0.03$ and $K_u=300$. For the adaptive fuzzy sliding mode control scheme, the sliding mode surface is $s(k) = c_1 e(k) + c_2$

$\dot{e}(k)$, the quantifying factors of the main fuzzy controller are $K_s=1, K_{sc}=0.03$; K_u is adjusted by the auxiliary adaptive fuzzy controller on line.

The auxiliary adaptive fuzzy controller is a variable coefficient fuzzy controller, which uses various quantifying factors under the condition of fast load changes or non-fast load changes. When the load is 5Ω , the quantifying factors are $K_e=50, K_{ec}=0.001, K_u=-20$; and when the load turns to 10Ω , the quantifying factors are $K_e=35, K_{ec}=0.001, K_u=-37$.

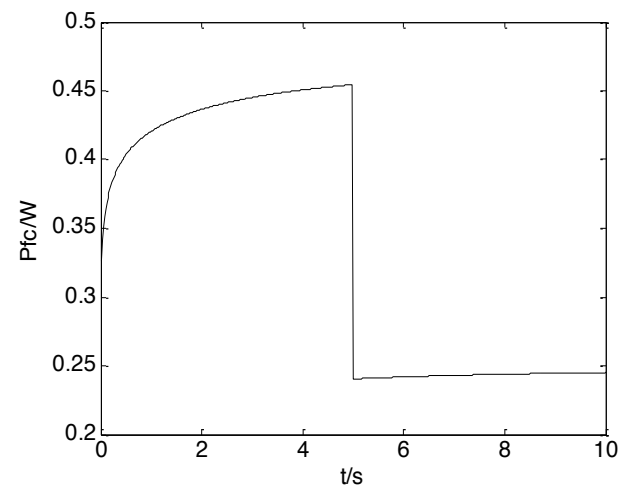
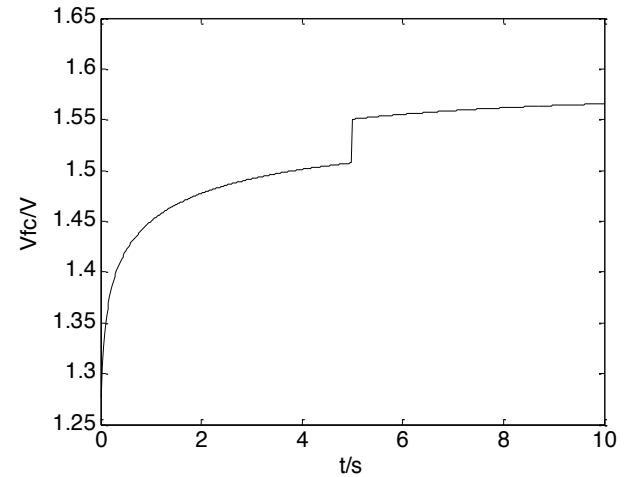

Fig. (7). Simulation results of uncontrolled PEMFC.

Simulation results compared between these three control schemes are shown in Figs. (8, 9).

Some phenomena can be observed from these figures. The fuzzy controller can make the PEMFC output a constant voltage basically. However, the response speed is relatively slow and the steady error is obvious. In the case of using the conventional fuzzy sliding mode controller, the response has been speeded up and the steady error was diminished, but a certain level of overshoot has occurred.

Table 3. Main parameters of the PEMFC.

B/V	A/cm^2	T_{fc}/K	P_{H_2}/Pa	R_c/Ω	l/cm	ψ
0.016	50.6	343	101325	0.0003	0.0178	23

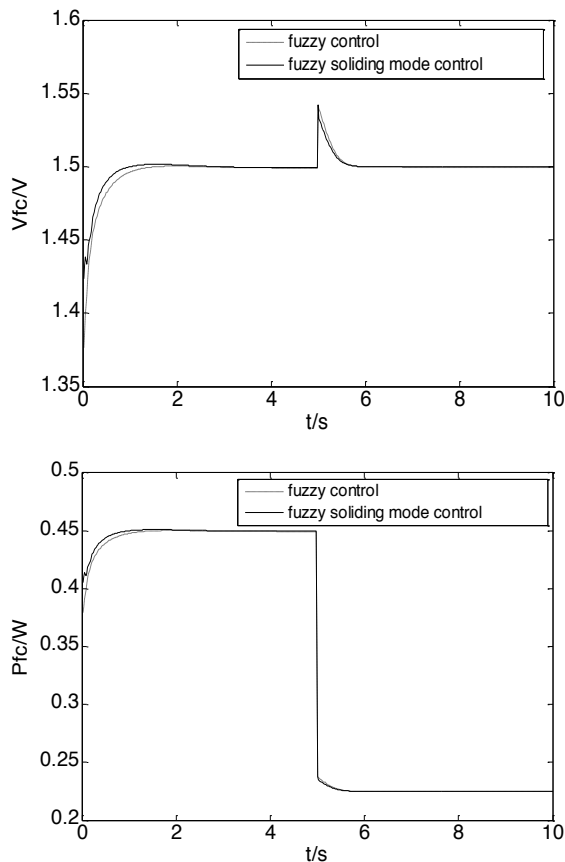

Fig. (8). Simulation results comparing fuzzy SMC with fuzzy control.

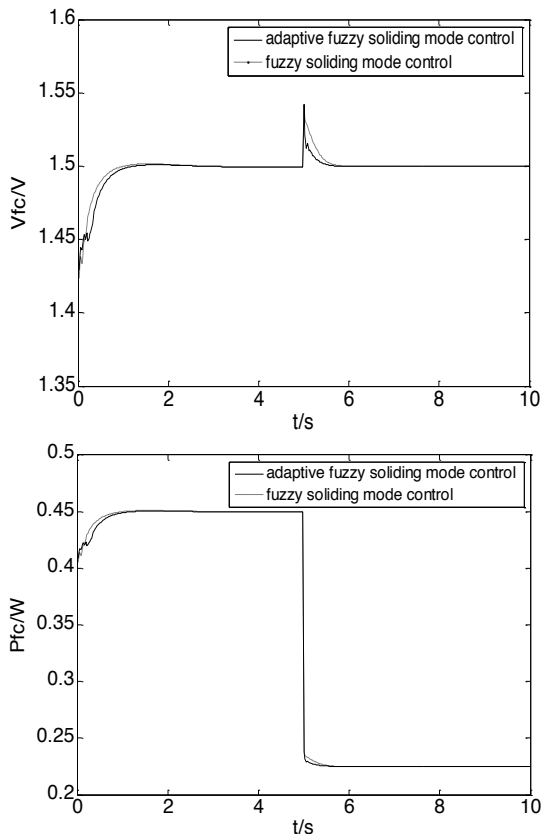

Fig. (9). Simulation results comparing adaptive FSMC with FSMC.

It must be pointed out that the appropriate quantifying factors for the fuzzy controller and fuzzy sliding mode controller used in this paper were chosen by vast repeated trials, and the load disturbance must be known in advance in order to adjust the fuzzy controller to the appropriate factors. This means lots of work must be done to get better results. However, if the adaptive fuzzy sliding mode control scheme is applied to the PEMFC, the appropriate factors can be obtained adaptively, faster response characteristic can be obtained, overshoot can be weakened, and the steady-state behavior gets better.

CONCLUSION

Although nonlinearity and complexity appear in the proton exchange membrane fuel cell system, the adaptive fuzzy sliding mode control scheme proposed in this paper can give satisfied control effect on the system. Adaptive fuzzy sliding mode control can give faster response characteristic and better steady-state behavior than fuzzy control and conventional fuzzy sliding mode control, and it has the adaptive ability to resist to load disturbance.

ABOUT THE AUTHORS

First Author Fan Liping, University professor of Shenyang University of Chemical Technology, Ph.D. The author's major is Control Engineering. 40 papers received by EI or SCI and 3 patents had been published.

Second Author Li Chong, master degree in engineering, enrolled for PhD in University of Chemical Technology and Metallurgy-Sofia. The author's major is Control Engineering.

Third Author K. Boshnakov, University professor of University of Chemical Technology and Metallurgy-Sofia, Ph.D.

CONFLICT OF INTEREST

The authors confirm that this article content has no conflict of interest.

ACKNOWLEDGEMENTS

This work was supported by the Science and Technology special fund of Shenyang City under Grant F14-207-6-00.

REFERENCES

- [1] Zhao, H.L. An investigation and study of the terminal energy consumption in Beijing. *Int. J. Business Manag.*, **2008**, 3(4), 174-178.
- [2] Kilic, F.C. Recent renewable energy developments, studies, incentives in Turkey energy. *Energy Educ. Sci. Technol. Part A*, **2011**, 28(1), 37-54.
- [3] Chirinoso, L.; Roseb, N.L.; Urrutiaa, R.; Muñozc, P.; Torrejóna, F.; Torresd, L.; Crucesd F.; Aranedaa, A.; Zarore, C. Environmental evidence of fossil fuel pollution in Laguna Chica de San Pedro lake sediments (Central Chile). *Environ. Pollut.*, **2006**, 141(2), 247-256.
- [4] Rahman, D.M.; Sakhawat, N.B.; Amin, R.; Ahmed, F. Ensuring energy security in future: a study on different strategic plans and related environmental impacts. *J. Sustain. Energy*, **2012**, 3(1), 71-75.
- [5] Das, S.; Mangwani, N. Recent developments in microbial fuel cells: a review. *J. Sci. Indust. Res.*, **2010**, 69(10), 727-731.

- [6] Kaya, D.; Kilic, F.C. Renewable energies and their subsidies in turkey and some EU countries Germany as a special example. *J. Int. Environ. Appl. Sci.*, **2012**, 7(1), 114-127.
- [7] Logan, B.E. Scaling up microbial fuel cells and other bioelectrochemical systems. *Appl. Microbiol. Biotechnol.* **2010**, 85(6), 1665-1671.
- [8] Gencoglu, M.T.; Ural, Z. Design of a PEM fuel cell System for residential application. *Int. J. Hydrogen Energy*, **2009**, 34(2), 5242-5248.
- [9] Kirubakaran, A.; Jain, S.; Nema, R.K. A review on fuel cells technologies and power electronic interface. *Renew. Sustain. Energy Rev.*, **2009**, 13(9), 2430-2440.
- [10] Wee, J.H. Applications of proton exchange membrane fuel cell systems. *Renew. Sustain. Energy Rev.*, **2007**, 11(8), 1720-1738.
- [11] Sedighzadeh, M.; Rezaei, M.; NajmiA, V. Predictive control based on neural network for proton exchange membrane fuel cell. *World Acad. Sci. Eng. Technol.*, **2011**, 50, 457-460.
- [12] Rezazadeh, A.; Sedighzadeh, M.; Karimi, M. Proton exchange membrane fuel cell control using a predictive control based on neural network. *Int. J. Comput. Elect. Eng.*, **2010**, 2(1), 81-86.
- [13] Zhou, H.Y.; Liu, K.Z.; Feng, X.S. State feedback sliding mode control without chattering by constructing Hurwitz matrix for AUV movement. *Int. J. Automat. Comput.*, **2011**, 8(2), 262-268.
- [14] Fan, L.P.; Liu, Y.; Xie, Y.; Guo, R. Fuzzy sliding mode control for sequencing batch reactor wastewater treatment process. *J. Chem. Eng. Japan*, **2013**, 46(2), 167-172.
- [15] Nhivekar, G.S.; Nirmale, S.S.; Mudholker, R.R. Implementation of fuzzy logic control algorithm in embedded microcomputers for dedicated application. *Int. J. Eng. Sci. Technol.*, **2011**, 3(4), 276-283.
- [16] Corcau, J.I.; Stoenesc, E. Fuzzy logic controller as a power system stabilizer. *Int. J. Circuits Syst. Signal Process.*, **2007**, 3(1), 266-272.
- [17] Lin, W.S.; Chen, C.S. Robust adaptive sliding mode control using fuzzy modelling for a class of uncertain MIMO nonlinear systems. *IEEE Proc. Part D, Cont. Theory Appl.*, **2002**, 149(3), 193-201.
- [18] Sala, A.; Guerra, T.M.; Babuska, R. Perspectives of fuzzy systems and control. *Fuzzy Sets Syst.*, **2005**, 156(3), 432-444.
- [19] Hwang, C.L. A novel Takagi-Sugeno-based robust adaptive fuzzy sliding mode controller. *IEEE Trans. Fuzzy Syst.*, **2004**, 12(5), 676-687.
- [20] Carnes, B.; Djilal, N. Systematic parameter estimation for PEM fuel cell models. *J. Power Sources*, **2005**, 144(1), 83-93.
- [21] Moreira, M.V.; Silva, G.E. A practical model for evaluating the performance of proton exchange membrane fuel cells. *Renew. Energy*, **2009**, 34(7), 1734-1741.
- [22] Youssef, M.E.; Nadi, K.E.; Khalil, M.H. Lumped model "for proton exchange membrane fuel cell (PEMFC). *Int. J. Electrochem. Sci.*, **2005**, 5, 267-277.
- [23] Mammam, K.; Chaker, A. Fuzzy logic control of fuel cell system for residential power generation. *J. Elect. Eng.*, **2009**, 60(6), 328-334.
- [24] Rezazadeh, A.; Askarzadeh, A.; Sedighzadeh, M. Adaptive inverse control of proton exchange membrane fuel cell using RBF neural network. *Int. J. Electrochem. Sci.*, **2011**, 6, 3105-3117.
- [25] Fan, L.P. Simulation study on the influence factors of generated output of proton exchange membrane fuel cell. *Appl. Mech. Mat.*, **2012**, 121-126, 2887-2891.
- [26] Correa, J.M.; Farret, F.A.; Canha, L.N.; Simoe, M.G. An electrochemical-based fuel-cell model suitable for electrical engineering automation approach. *IEEE Trans. Indust. Electron.*, **2004**, 51(5), 1103-1112.

Received: December 5, 2014

Revised: January 23, 2015

Accepted: March 5, 2015

© Fan et al.; Licensee Bentham Open

This is an open access article licensed under the terms of the Creative Commons Attribution Non-Commercial License (<http://creativecommons.org/licenses/by-nc/4.0/>) which permits unrestricted, non-commercial use, distribution and reproduction in any medium, provided the work is properly cited.