

Compoforming of Al-Si Metal Matrix Composites Reinforced with β -SiC: An Alternative Technique

M. F. Valencia García^{1,*}, H. V. Martínez² and A. Morales Ortiz²

¹Escuela de Ingeniería de Antioquia; Grupo Productividad hacia la Competitividad GPC – A.A. 7516 Medellín, Colombia

²Universidad Pontificia Bolivariana; Facultad de Ingeniería Mecánica. Grupo de Investigación sobre Nuevos Materiales GINUMA – A.A. 56006 Medellín, Colombia

Abstract: This paper reports the β -SiC particles surface modification by copper Electroless Plating (EP), as well as a morphological characterization of Al-Si reinforced composite obtained with such modified particles and consolidated by compoforming. The β -SiC particles were obtained by thermal degradation of organic waste. The compoforming technique is a hybrid between the compocasting process and semi-solid forging. The properties of the obtained composite material derive from its globular structure, which is achieved by mixing the semi-solid alloy and the reinforcing particles. This method produced an almost perfect distribution of the reinforce particles. Furthermore, it is possible to achieve minimum defects (i.e. porosity) by applying pressures up to 60MPa.

Keywords: Silicon carbide, electroless plating, superficial modification, mechanical mixing, compoforming.

INTRODUCTION

About 35 years ago, semi-solid metallurgy, or semi-solid processing of alloys (SSM and SSP, respectively), was originated. This technology combines the advantages of traditional forging and foundry processes. Nowadays such technology and the development of Metal Matrix Composites (MMC's) have been strong, combining dispersion process to obtain Particulate reinforced Metal Matrix Composites (PRMCs).

The foundry techniques in which the metal matrix is in the semi-solid state are of particular interest in the production of PRMC's, because they gather energy savings and good particle dispersion. One of these techniques is Compo-casting. This technique is actually a variation of the Stircasting process, in which the metal is not completely melted [1]. Stirring can be followed by die-casting to obtain ingots [2].

EXPERIMENTATION

β -SiC

β -SiC microparticles were obtained as reported in [3]. Rice husk (RH) was immersed in a $\text{FeCl}_2 \cdot 4\text{H}_2\text{O}$ bath for one hour, and immersion in a NH_4OH solution was done to precipitate the remaining Fe. Afterwards, the RH was washed with distilled water at 25°C and dried at 80°C for 12 hours; then the RH was subjected to controlled pyrolysis. Table 1 shows the most important variables of the process.

Table 1. Process Conditions for β -SiC Synthesis

Variable	Value	Unit
Process temperature	1370	°C
Atmosphere process	1.5	L/min
Processing times	40	min
Catalyst	$\text{FeCl}_2 \cdot 4\text{H}_2\text{O}$	-

Superficial Modification of β -SiC

Several possibilities are available to improve wetting, between SiC and Al such as reactive elements, i.e. Li, Mg, Si [4] or using metallic coatings to generate a metal-metal interface, and hence a higher wettability.

Previous investigations have shown that the usage of Ni or Cu coatings is effective, resulting in an increase of the resistance of the composite, its toughness and a better dispersion of the reinforce particles within the molten metal [5, 6]. In this work, the β -SiC particles were coated with Cu as it follows.

Electroless Plating (EP)

The plating process was adapted from that of Sharma *et al.* [7]. In their work, the authors studied the effects of pH and temperature of the plating bath on the quality and quantity of the deposited Cu for ceramic nanoparticles.

Pretreatment

Since the EP technique is a chemical reduction process, the preparation of the surface where the metal will be deposited is essential. That is why the particles were immersed in

*Address correspondence to this author at the Escuela de Ingeniería de Antioquia, Grupo Productividad hacia la Competitividad GPC, A.A. 7516 Medellín- Colombia, Tel: (57) 4 3549090, Fax: (57) 4 3861160; E- mail: pfmaval@eia.edu.co

SnCl₂ and PdCl₂ solution, respectively. Table 2 lists the details of the pretreatment of the particles.

Coating

Once the particles were catalyzed, they were taken to the plating bath, which is constantly stirred, in which the reduction reaction took place. This bath consists of a metallic ions solution of cupric sulfate, formaldehyde as a reducing agent and sodium-potassium tartrate (Rochelle's salt) as a complexing agent, which stops the metallic salt from precipitating.

Table 2. Superficial Pretreatment of β -SiC

Solution	Chemical Species	Concentration	Operation	Time
Sensitization ml	SnCl ₂ .2H ₂ O HCl	20g/l 0.5 ml/l	Mechanical stirring (400 rpm)	30
Wash water PH 7.0 and vacuum filtration				5
Activation 2000 ml	HCl PdCl ₂	5.5 ml/l 0.25 g/l	Mechanical stirring (400 rpm)	35
Wash water PH 7.0 and vacuum filtration				5

Stirring was maintained and, as the reaction run out, the solution color changed until it gets a transparent appearance (Fig. 1), as soon as the Cu from the solution was deposited on the surface of the ceramic particles as metallic Cu.

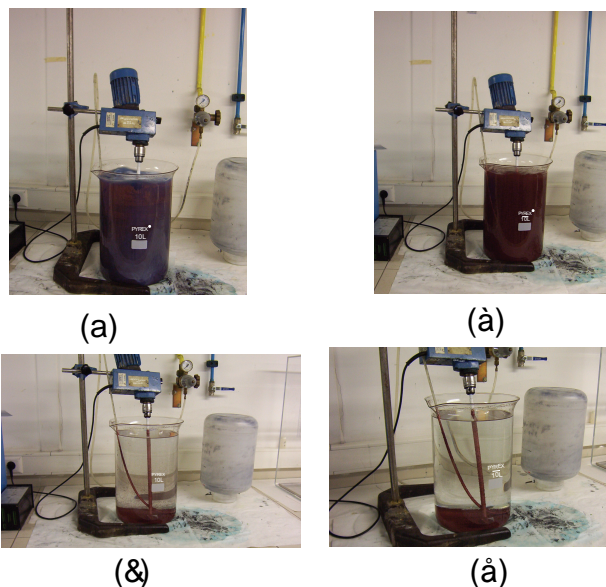

Fig. (1). Evolution of the plating bath: (a) 0 min., (b) 10 min., (c) 30 min., (d) 40 min.

The temperature of the bath was kept at 80°C while pH was kept at 12.0. Table 3 summarizes the details of the plating process.

Drying

As soon as the coating reaction was ended, the particles were washed with water and then subjected to vacuum (-1 bar) at 60°C for one hour, to dry them.

Table 3. Parameters for the EP of β -SiC

Solution (mL)	Chemical Species	[]	Role in the Bath	Operation	Time (min)
Coating 3000 mL	CuSO ₄ .5H ₂ O	10 g/L	Metal ions coating	Mechanical stirring 1200 rpm	To complete reaction
	CH ₄ O ₆ NaK.4H ₂ O	50 g/L	Complexing		
	HCHO	15m/L	Reducer		
	NaOH	To adjust pH	Buffer solution for PH control		
Wash water PH 7.0 and vacuum filtration					5

Morphology of Modified β -SiC

Fig. (2a) is a SEM image of β -SiC particles after the sensitization bath. Fig. (2b) shows the qualitative analysis, indicating the presence of Sn, which was used as catalyst in the SnCl₂ bath. Fig. (3a) shows the coated β -SiC particles. Again, elemental analysis shows the presence of Sn and Pd from the pretreatment process. On the other hand, a high amount of Cu can be seen due to the plating process.

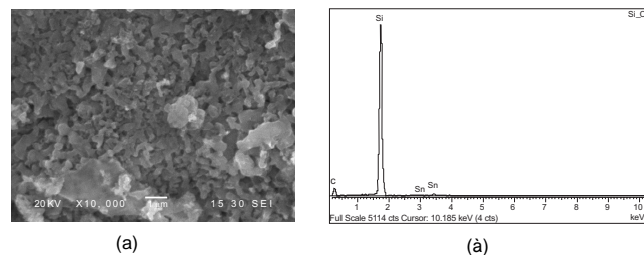

Fig. (2). β -SiC particles without Cu: (a) SEM image, (b) field EDS.

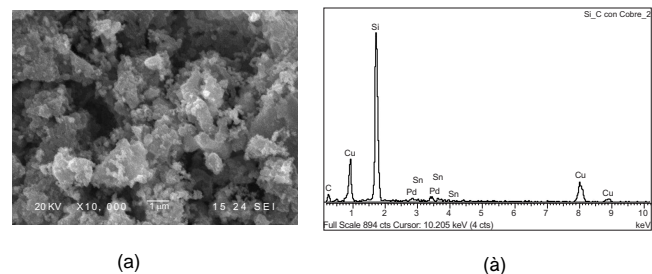

Fig. (3). Modified β -SiC particles: (a) SEM image, (b) field EDS.

Fig. (4a) is an image of coated particles. From punctual EDS in three different zones (Fig. 4b), C, Si, Sn and Cu can be found, being Cu the most abundant, with an average of 79.27% wt (Table 4).

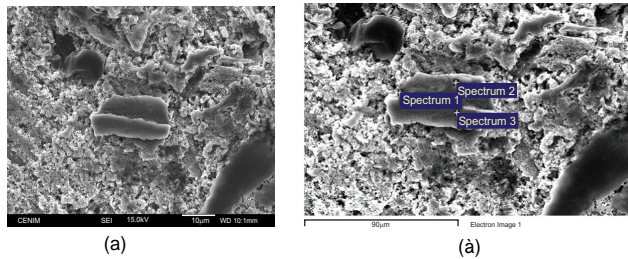

Fig. (4). Cu coated β -SiC particles: (a) SEM image, (b) punctual EDS.

Table 4. Chemical Composition as Shown in figure 4b.

Element	% (wt)	% (at.)
C	4.83	16.05
O	12.04	30.00
Si	2.67	3.79
Cu	79.27	49.75
Sn	1.19	0.40
Total	100.00	

Cu/ β -SiC Microcomposites

Powdered Cu/ β -SiC microcomposites were obtained as shown in Fig. (5). As stated before, the pH maintained in the plating bath was 12.0, even though Sharma *et al.* suggest an optimum of 12.5. An increase in the weight of the initial β -SiC particles of 32% was achieved.



Fig. (5). β -SiC particles without coating (left) compared to the Cu/ β -SiC microcomposite (right).

Regarding Fig. (5), it is remarkable that the drying process is important for the consolidation of the composite; if it is not done under controlled atmosphere, the coating will oxidize, turning to a particular color depending on the type and amount of oxide, i.e. Cu_2O or CuO . In their studies, Kim *et al.* [8] have suggested that the presence of Cu_2O could provoke an increase in the individual volume of the fibers, favoring their agglutination due to the high adherence of this oxide (Fig. 6).

Bárcena [9] further explains that the superficial oxide is detrimental for later sintering of the composite, hindering

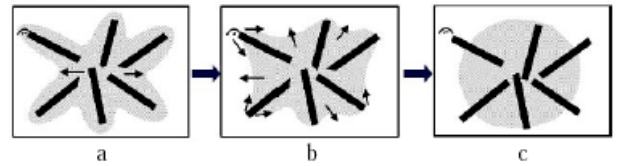

Fig. (6). Model of Kim and Lee: (a) Composite (b) CuO (Cu_2O) transformation, volume and contact increase, training necks at the point of contact, (c) geometry adopted to reduce the surface energy [8].

coalescence into bigger grains and forming agglomerations during their growing phase. Electrochemical corrosion could also occur, forming Cu_2O [10].

Morphology Of Coated Particles

During the coating process, small microscopic particles of Cu start to adhere to the surface of β -SiC, layer by layer. The process is then repeated until all the Cu in the solution has been deposited onto the β -SiC. Additionally, it is probable that not all the β -SiC surface be coated, since the overlapping of Cu layers could cover small pores (Fig. 7).

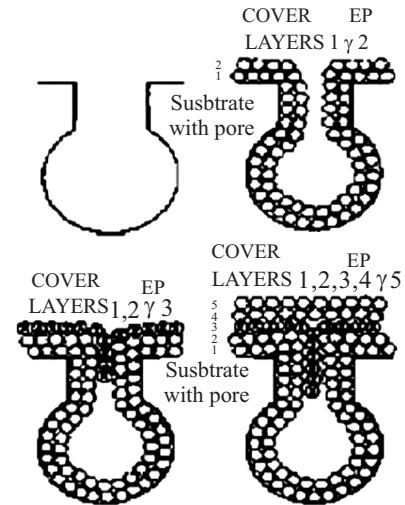

Fig. (7). Monolayer coating mechanism as seen in the EP process [7].

Fig. (8) evidences the globular monolayer coating process in the modified particles, as proposed by Sharma *et al.* [7]. Note the spherical shape of the small Cu globules on the surface of the β -SiC. It is also important to note that this

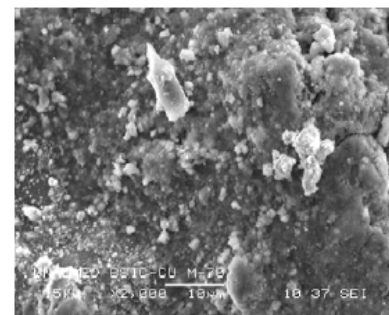

Fig. (8). Cu modified β -SiC.

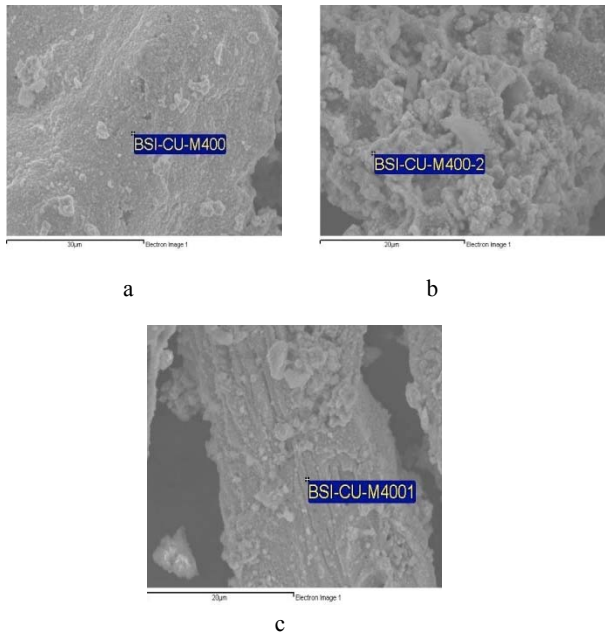

Fig. (9). Cu layer thickness values in β -SiC: (a). 0.54 μm , (b) 0.55 μm , (c) 0.62 μm .

plating process happens equally for every particle size, thus, if different particle sizes were being plated in the same bath, both would be covered with the same amount of Cu; nonetheless, the smaller particles would have a thicker layer. This is why this plating mechanism guarantees a homogeneous amount of Cu in all the particles (of the same particles size). Fig. (9) shows the particle thickness which was measured through EDS.

Compcasting of Al – Si Metal Matrix Composites

The production method of PRMC’s by Compcasting is shown in Fig. (10). The consolidation of PRMCs requires the correct control of the process parameters [11].

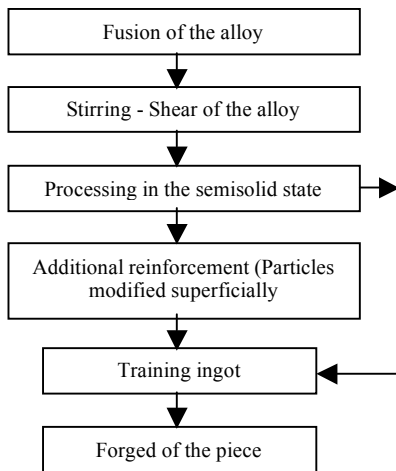

Fig. (10). Production route for compocasting PRMC’s.

Semi-Solid Forging

The semi-solid forging process of a part was initially simulated using CFD tools (Flow-3D Software, from Flow

Science Co.). Fig. (11) is a CAD image of the processed part.

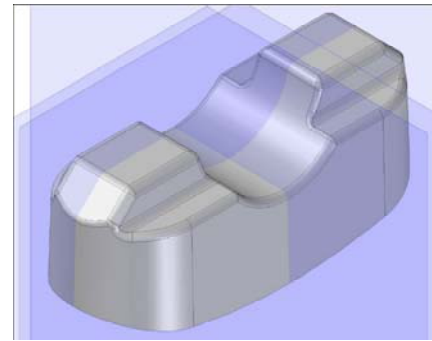

Fig. (11). Objective part to be created by Compcasting (electrical connector clamp).

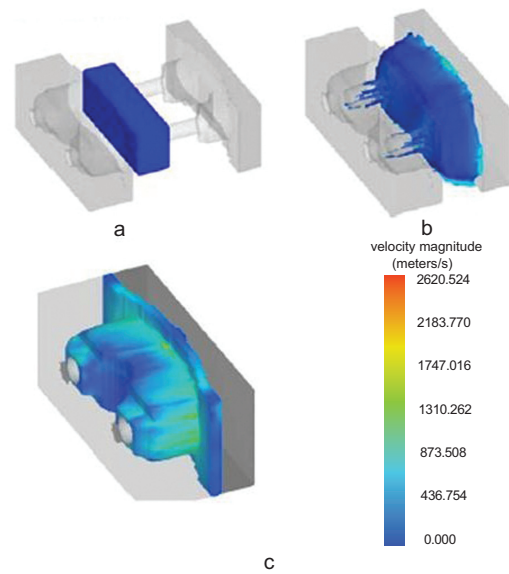

Fig. (12). (a) initial position of the ingot and mold (b) Pressing of the composite paste. (c) Velocity profiles.

In Fig. (12a-c), a part of the simulation is shown which was used in the determination of the flow velocity profile of the material inside the molding system during the semi-solid forging process. With this simulation it was possible to determine zones where defects could develop instantly, as well as sites where interlaminar differences could generate irregular and turbulent flow. This figure also shows the velocity profile in three different instants for the part. It can be seen that in the external part of the mold there is an increase in the velocity of the flow. Despite the high velocity, the front of the material inside the mold presents time divisions, which, due to pressure, are eliminated, thus avoiding defects by gas inclusion.

In this study, the initial stage of the process Squeeze casting (SC) is slightly modified during the *in situ* preparation of the composite paste by stirring. After obtaining a homogeneous composite, die cast is done in order to obtain an ingot by applying moderate pressure for 12 to 15 s. Semi-solid forging of the composite ingot and the following solidification process take place when 50 to 100 MPa pressure is applied. (Fig. 13).



a



b



c

Fig. (13). (a) Compoforming device. (b) Stirring system in detail. (c) Electric oven in detail.

Treatment of the Alloy Matrix

The fusion of the alloy takes place at 617°C, according to the cooling curve (Fig. 14). Degasification is frequent in Al smelting but in this case it was not used because the entire process was carried out in Ar atmosphere. The immersion of the agitator and continuous stirring happens once the alloy has melted.

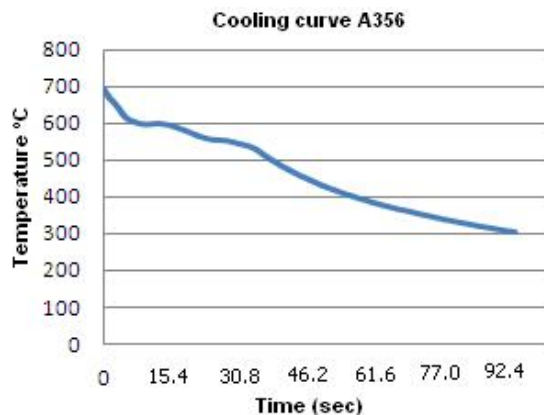

Fig. (14). Cooling curve of the alloy matrix.

Mixing with the Reinforce

The stirring system used in this study consisted in a right cylinder shaped crucible and a propeller blade mixer, pre-

heated at 590°C, Both, the crucible and the mixer were coated with zirconium paint. In an effort to increase the shear efficiency of the material, and avoiding the formation of an external vortex, the blades were angled at 45° in the upper part of the mixer, hence preventing the engulfing of gases and promoting particle dispersion. The mechanism has been further enhanced with a set of right blades in the lower part of the mixer to prevent particles from sedimenting on the bottom of the crucible.

Afterwards, the temperature of the system was lowered until 593°C. At this temperature, according to Fig. (14), a maximum of 40%wt of solid phases is ensured. This fraction has also been reported in similar studies [12]. Stirring is done at 600 RPM, and, after adding the reinforcer particles, maintained for 10min. Balasivanandha *et al.* [13] have also reported similar timing for the production of PRMC's through stirring. The general variables are listed in Table 5.

Table 5. Variables for the General Compoforming and Forging Composite Al-Si7-Mg0.3/β-SiCp/15wt.

Variable	Value	Units
Temperature compocasting	593	°C
time Stirring	10	min
Speed stirring	600	rpm
Atmosphere process	0.5	L/min
Particle Percentage	15	% wt
Particle size	38	μm
Pressure forging	60	MPa
While keeping the pressure	12	s
Temperature molds	180-220	°C

Morphology of the Composite

Fig. (15) shows the Al-Si7-Mg0.3/β-SiCp/15wt composite thermally treated (TT). The presence of β-SiC in the eutectic phase should be noted, since, being the last one to solidify, houses the solid reinforced during the entire process.

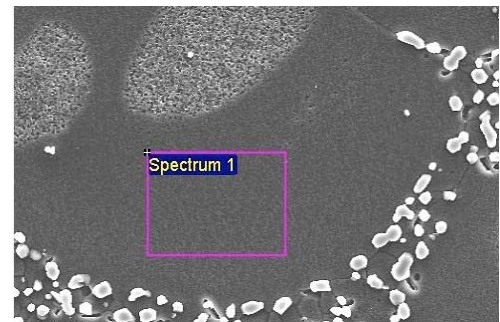

Fig. (15). Al-Si7-Mg0.3/β-SiCp/15wt composite with T.T. Once the composite had been synthesized, forging and part obtaining where followed.

Finally, the parts underwent TT, i.e. treatment in solution at 548°C for 8 hours followed by cooling with cooling water and artificial aging (T6) at 170°C during 6 hours and cooling with air. Fig. (16) shows an image of the compoforged part.



Fig. (16). Compoforged part.

Mechanical Behavior

Table 6 summarized the mechanical properties of the materials processed by Compoforging. It is evident that an increase in mechanical resistance and a reduction in the elongation percentage were achieved, as product of a high rigidity of the composite compared with the molten alloy.

Table 6. Alloy and the Piece Mechanical Properties with Thermal Treatment

Property	Al-Si7-Mg0.3-T6	Al-Si7-Mg0.3-T6/ β -SiC
Ultimate strength MPa	220	380
Yield strength MPa	180	345
Elongation percentage	18	10
Hardness HB	110	130

CONCLUSIONS

Micrometric β -SiC particles, obtained by controlled pyrolysis of rice husk, have been modified with Cu through Electroless Plating, at pH 9.4 and 80°C, achieving an increase of 32% wt.

EP coatings enhance the adhesion between Cu and β -SiC. Furthermore, the wetting issue between Al and β -SiC is surpassed.

Semi-solid compoforging systems for obtaining PRMC's parts seek, among others, achieving microstructural changes, as well as producing zero defects parts, which can be done thanks to high induced pressure, the last one promoting densification.

A novel technique for manufacturing parts from PRMC's has been designed and tuned. Since the device and processing routes are similar to the conventional ones used in smelting, it is possible to state that mechanical stirring together with semi-solid forging show interesting advantages to obtain diverse pieces, due to their low cost and easy process implementation.

A PRMC, Al-Si7-Mg0.3-T6/ β -SiC/15wt, has been processed by compoforging. It was possible to achieve an increase in its resistance, due to the solidification phenomenon which happens under pressure, beside the thermal treat-

ments. Additionally, the precipitation of intermetallic compounds, plus the effect of small β -SiC ceramic particles, create higher barriers for dislocations. This reinforcing mechanism will depend, however, of the space amongst particles and their distribution within the matrix.

Finally, direct combination of melting and forming a part in one stage, as mentioned in this paper, reduces production stages, as well as time and energy consumption.

ACKNOWLEDGEMENTS

The authors wish to thank Colciencias for funding the project under grant No. 12100817302, as well as the Universidad Pontificia Bolivariana for financial support with the project 802-11/05-S21.

REFERENCES

- [1] K.O. Umit Cocen, "The production of Al-Si alloy-SiCp composites via compocasting: some microstructural aspects", *Materials Science and Engineering*, vol. 221, pp. 187-191, 1996.
- [2] G. R. P. A.M. Gokhale, "Analysis of variability in tensile ductility of a semi-solid metal cast A356Al alloy", *Materials Science and Engineering A*, vol. 392, pp. 184-190, 2005.
- [3] H. V. Martínez, M. F. Valencia, L. J. Cruz, J. M. Mejía, and F. Chejne, "Production of β -SiC by pyrolysis of rice husk in gas furnaces", *Ceramics International*, vol. 32, no. 8, pp. 891-897, 2006.
- [4] G. Wang, and J.J. Lannutti, "Static wetting of a liquid drop on a solid", *Journal of Materials Science*, vol. 30, pp. 3171-3176, 1995.
- [5] C. A. Leon, and R. A. L. Drew, "Preparation of nickel-coated powders as precursors to reinforce MMCs", *Journal of Materials Science*, Vol. 35, pp. 4763-4768, 2000.
- [6] W. S. Chung, and S. J. Lin, "Ni-coated SiC_p reinforced aluminum composites processed by vacuum infiltration" *Plating Surface Finish*, vol. 83, pp. 68-71, 1996.
- [7] R. Sharma, R. C. Agarwala, and V. Agarwala, "Development of copper coatings on ceramic powder by electroless technique", *Applied Surface Science*, vol. 252, no. 24, pp. 8487-8493, 2006.
- [8] I. S. Kim, S. K. Lee, "Fabrication of carbon nanofiber/Cu composite powder by electroless plating and microstructural evolution during thermal exposure," *Scripta Materialia*, vol. 52, pp. 1045-1049, 2005.
- [9] J. Bárcena, "Estudio de oxidación y comportamiento en corrosión de composites de matriz de cobre y aluminio, reforzados con nanofibras y nanotubos de carbono," *Ph.D. tesis, Escuela de Ingenieros, Universidad del País Vasco*, Bilbao 2005.
- [10] F. J. Ansuini, C. W. Dralle, F. King, W. W. Kirk, T. S. Lee, Henry Leidheiser, Jr., Richard O. Lewis, G. P. Sheldon, "Corrosion of Copper and Copper Alloys," *Corrosion*, vol. 13, ASM Handbook, ASM International, 1987, pp. 610-640.
- [11] H. V. Martínez, M. F. Valencia, F. Chejne y J. Cruz, "Procesado por Compocasting y caracterización de composites metálicos reforzados con fibrillas de β -SiC obtenidas desde la cascarilla de arroz". Parte II. Fabricación de composites, *MATCOMP-2005, VI Congreso nacional de materiales compuestos, Asociación Española de Materiales Compuestos*, Universidad de Valencia, Valencia, España, pp. 27-29, 2005.
- [12] J. Coleto, "Fabricación y caracterización de un material compuesto base aluminio reforzado con fibras cortas de carbono por las técnicas de mezcla en estado líquido/semisólido y forja líquida sobre preformas porosas", *Ph.D. tesis, Universidad Complutense de Madrid*, Madrid, 2000.
- [13] L. K. S. Balasivanandha, S. Kathiresan, and B. Mohan, "Influence of stirring speed and stirring time on distribution of particles in cast metal matrix composite", *Journal of Materials Processing Technology*, vol. 171, pp. 268-273, 2006.